

MPX R1

MIDI Remote Controller

User Guide

lexicon

Unpacking and Inspection

After unpacking the MPX R1, save all packing materials in case you ever need to ship the unit. Thoroughly inspect the unit and packing materials for signs of damage. Report any shipment damage to the carrier at once; report equipment malfunction to your dealer.

Notice

This equipment generates and uses radio frequency energy and if not installed and used properly, that is, in strict accordance with the manufacturer's instructions, may cause interference to radio and television reception. It has been type tested and found to comply with the limits for a Class B computing device in accordance with the specifications in Subpart J of Part 15 of FCC Rules, which are designated to provide reasonable protection against such interference in a residential installation. However, there is no guarantee that interference will not occur in a particular installation. If this equipment does cause interference to radio or television reception, which can be determined by turning the equipment OFF and ON, the user is encouraged to try to correct the interference by one or more of the following measures:

- Reorient the receiving antenna
- Relocate the computer with respect to the receiver
- Move the computer away from the receiver
- Plug the computer into a different outlet so that the computer and receiver are on different branch circuits.

If necessary, the user should consult the dealer or an experienced radio/television technician for additional suggestions. The user may find the following booklet prepared by the Federal Communications Commission helpful:

"How to identify and Resolve Radio/TV Interference Problems."

This booklet is available from the U.S. Government Printing Office, Washington, DC 20402, Stock No. 004-000-00345-4.

Le présent appareil numérique n'émet pas de bruits radioélectriques dépassant les limites applicables aux appareils numériques de la class B prescrites dans le Règlement sur le brouillage radioélectrique édicté par le ministère des Communications du Canada.

Contents

1 Product Overview	
Introduction	1-1
The Front Panel	1-2
The Rear Panel	1-3
Installation Notes	1-4
Power Requirements	1-4
Connecting the MPX R1 to an MPX 1	1-4
Stand-alone Configuration	1-4
2 The MPX R1 as a Dedicated MPX 1 Controller	
MPX 1 Software Requirements	2-1
MPX 1 and MPX R1 Connections	2-1
Working in Program Mode	2-1
A/B, Tap/Tempo, Bypass, Toe and Pedal	2-1
Loading Programs	2-2
Direct Access Mode	2-2
FX Mode	2-3
Relay State Programming	2-3
Changing Programs vs. Bypassing Effects in a Guitar Rig	2-4
Using the MPX 1 and the MPX R1 in a Guitar Amp Effects Loop	2-4
Using the MPX 1 and the MPX R1 in a Preamp/Power Amp Rig or a Dry/Wet (3-way) Rig	2-5
Using a Series Loop	2-5
Using a Parallel Loop	2-6
3 Using the MPX R1 with Other MIDI Devices	
Connections	3-1
Working in Program Mode	3-1
A/B, Tap/Tempo, Bypass, and Toe Switch	3-1
Loading Programs	3-1
Direct Access Mode	3-2
FX Mode	3-2
Relay State Programming	3-3
4 Editing	
Edit Mode Program Parameters	4-2
Edit Mode FX Parameters	4-5
The Relays	4-6
Latching	4-6
Momentary, normally open	4-6
Momentary, normally closed	4-6
Relay State Programming	4-7
Assigning the Relay with tip and ring	4-7
Removing Relay Settings for all programs	4-7

Contents, cont'd.	5	Advanced Applications	
		Transmitting Multiple Program Changes on Separate MIDI Channels	5-1
		Setups	5-1
		Activating Setups and Direct Device Control	5-2
		Creating a Setup	5-1
		Setup Parameters	5-2
		Clearing a Setup	5-2
		Direct Device Control	5-3
		Alternative Connections	5-4
		2 MIDI Cables and an MSA Adapter	5-4
		5-pin Connection (1 Cable for two-way MIDI with power from an adapter)	5-4
	6	Troubleshooting	
		Low Voltage	6-1
		Overheating	6-1
		Common MIDI Problems	6-1
		Adjusting Pedal Tension	6-2
		Reinitialization	6-3
		Reinitialization of the MPX R1	6-3
		Reinitialization of the MPX 1 and the MPX R1	6-3
	7	Specifications	
		Specifications	7-1
		MIDI Implementation	7-2

Product Overview

Introduction

The MPX R1 MIDI Remote Controller performs as a dedicated MIDI controller for the Lexicon MPX 1, or as a stand-alone MIDI control unit. Either way you use it, you'll appreciate its rugged, road-worthy construction and straightforward control surface.

The MPX R1 has two basic operating modes: Program Mode and FX Mode. Program Mode is used for sending MIDI Program Change messages. FX Mode is used to send other MIDI data such as Controller messages, and for selecting the unit's built-in 4-state relay. When used with the MPX 1, FX Mode functions like a "virtual pedalboard". Individual effect blocks can be turned on and off, and three-state LEDs (off, red and green) indicate whether the effect block is unavailable (not programmed as part of the preset), off or on. The front panel FX button toggles between Program and FX modes.

In this manual, the available functions for different applications are presented separately — so you can easily find the sections you need to get up and running quickly.

This first section presents general information about the R1 controls, as well as some basic information on installation, connections and power requirements.

Chapter 2 concentrates solely on using the R1 with the MPX 1. Chapter 3 discusses the operation of the R1 as a stand-alone MIDI controller. Editing functions are discussed in Chapter 4, followed by a section detailing advanced applications.

The Front Panel

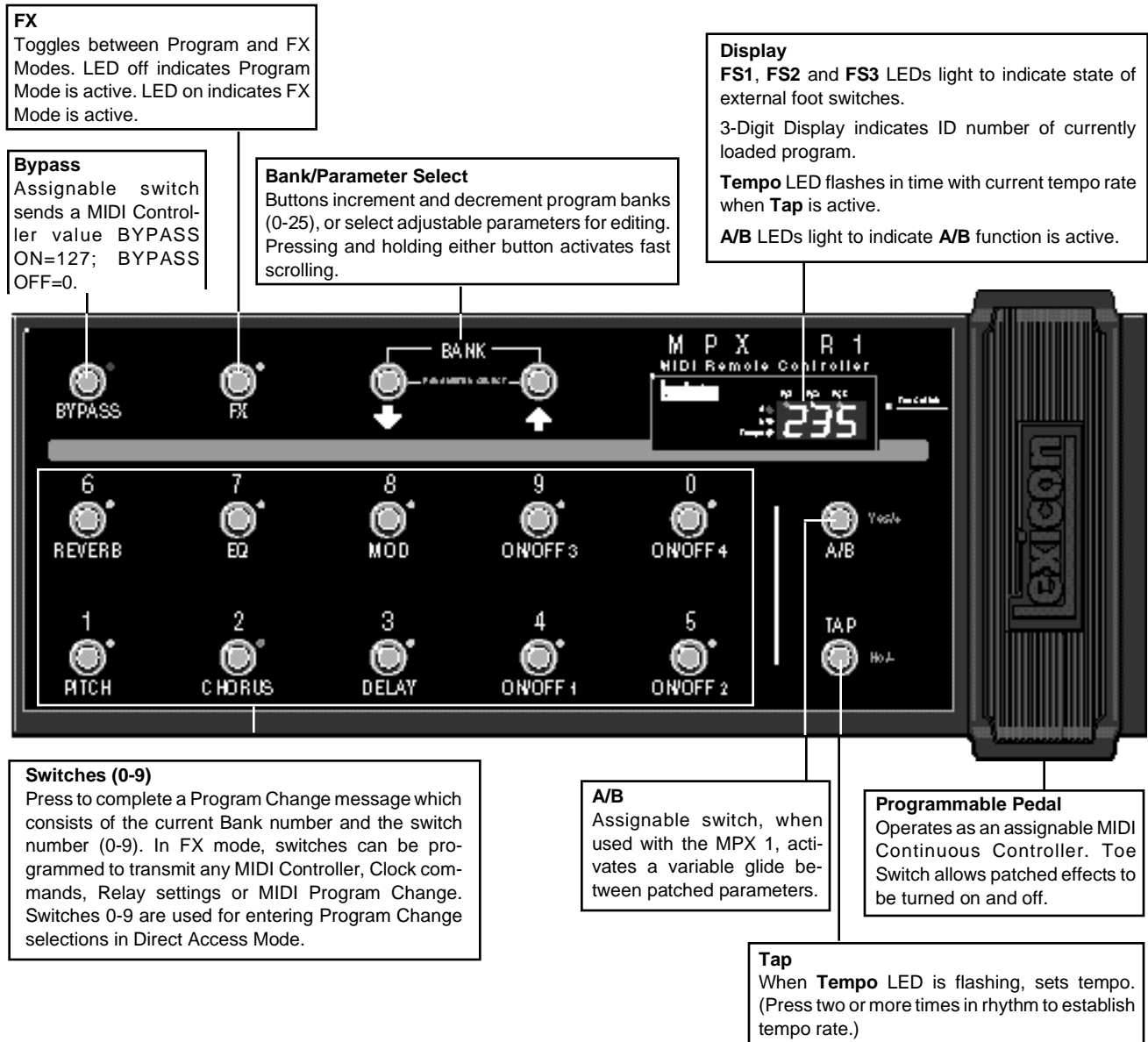

The Rear Panel

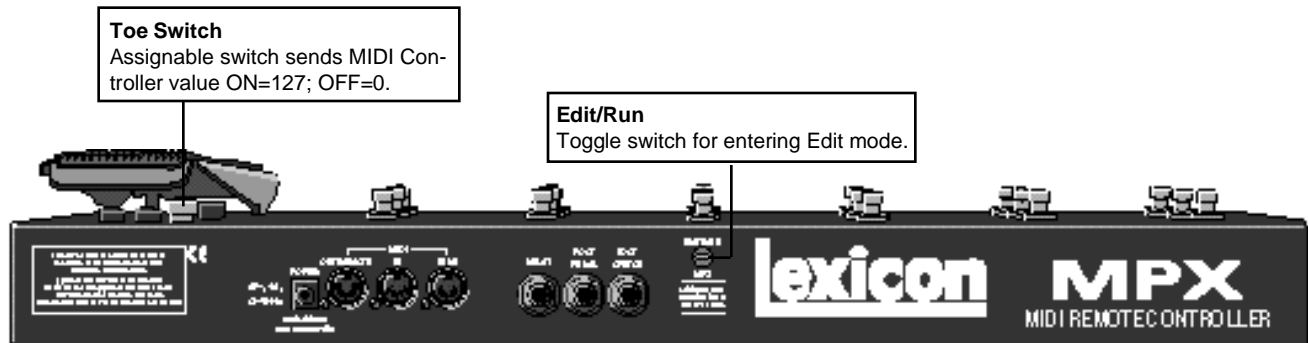

Toe Switch
 Assignable switch sends MIDI Controller value ON=127; OFF=0.

Edit/Run
 Toggle switch for entering Edit mode.

POWER
 Use Lexicon MSA power adapter, or 9 VAC 1 amp equivalent. Jack is unused when powering the MPX R1 with the 7-pin DIN connector.

Foot Pedal
 1/4" Tip/Ring/Sleeve phone jack provided for foot pedal with 10kΩ to 50kΩ impedance.

MIDI OUT/REMOTE
 5-pin DIN connector for MIDI OUT or
 7-pin DIN connector for MIDI OUT and bidirectional MIDI remote (for use with MPX 1).

IN
 5-pin DIN connector receives MIDI data from other equipment.

THRU
 5-pin DIN connector passes any MIDI data received without change.

Relay
 1/4" Tip/Ring/Sleeve phone jack software selectable as a momentary or latching switch.

Foot Switch
 1/4" Tip/Ring/Sleeve phone jack for as many as three independent footswitches.

Foot Switch

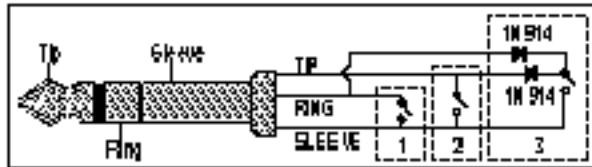

Foot Pedal

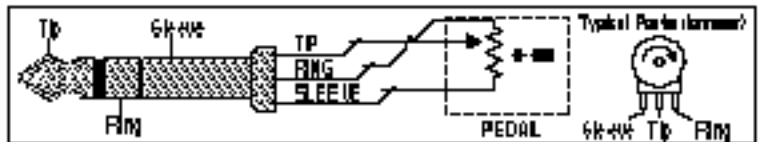

For control-voltage input, use a 1/4" stereo plug with Sleeve connected to ground, Tip connected to the control voltage, and Ring unconnected or shorted to ground..

Relay

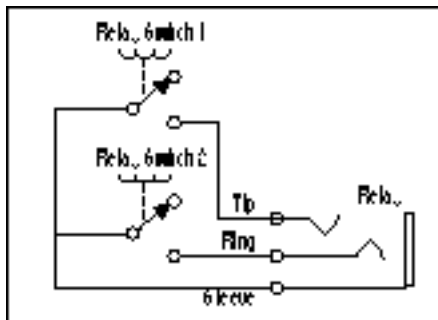

Installation Notes

Power Requirements Use Lexicon MSA power adapter, or 9 VAC 1 amp equivalent.

Connecting the MPX R1 to an MPX 1

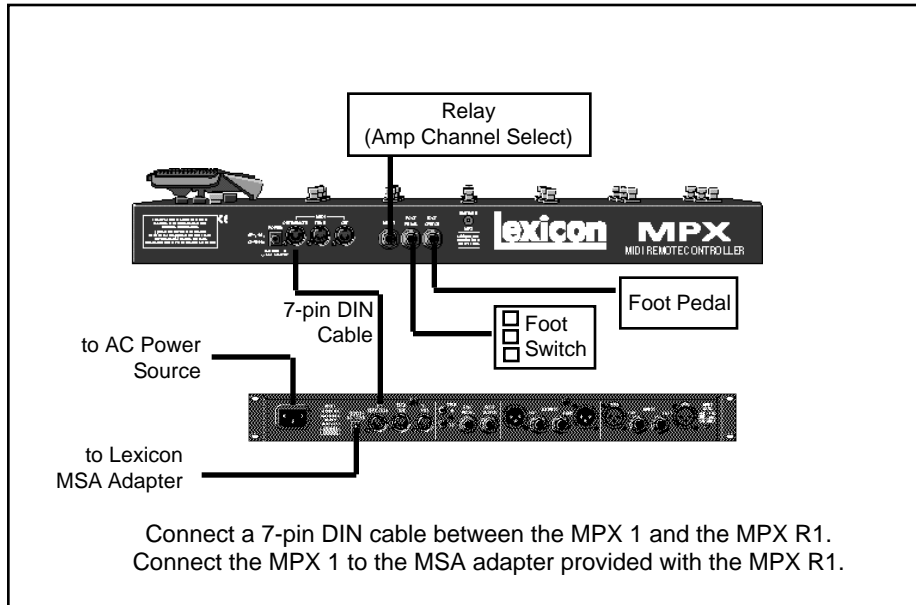

Stand-alone Configuration

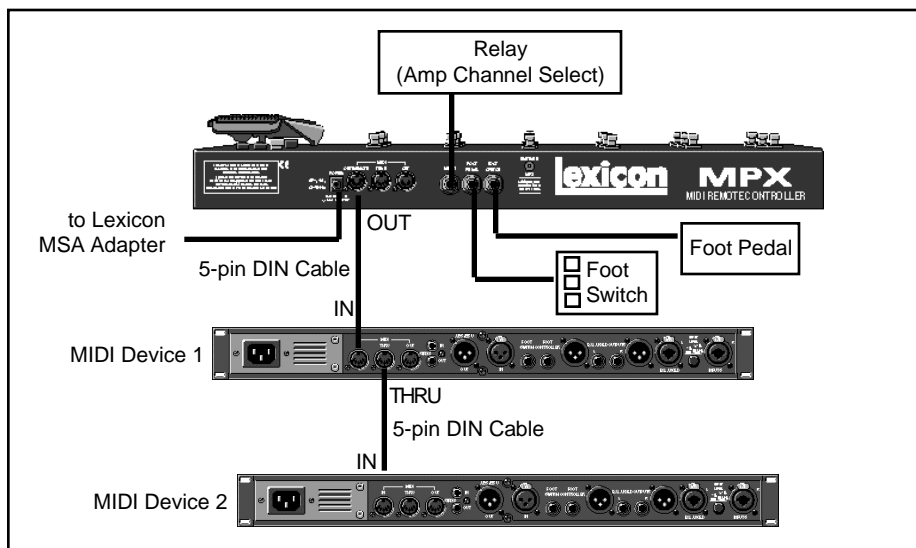

When an MPX R1 is connected to an MPX 1, two-way communication is accomplished via MIDI System Exclusive messages. This allows immediate response by both units to actions on either front panel.

The MPX R1 as a Dedicated MPX 1 Controller

Using the MPX R1 with the MPX 1 requires V1.10 software to be installed in the MPX 1. (The software version is shown on the MPX 1 display on power up.) Once this software is installed in your MPX 1, the following simple procedure will get you up and running quickly. Note that these instructions assume a general knowledge of MPX 1 operation. If you are a first-time MPX 1 user, please review the MPX 1 User Guide for general instruction.

MPX 1 Software Requirements

Connect the power adapter provided with the MPX R1 to the MPX 1 REMOTE POWER input jack and to a wall outlet.

MPX1 and MPX R1 Connections

Power up the MPX 1 and connect the 7-pin DIN cable provided with the MPX R1 between the MPX 1 rear panel IN/REMOTE jack and the MPX R1 MIDI OUT/REMOTE.

The MPX R1 will cycle through a power-up routine, lighting various LEDs, and then display **Con**. The MPX 1 will display **Remote Connected**. These messages indicate that proper bidirectional control has been established.

When the MPX 1 powers up, it will default to Program Mode. The MPX R1 should also power up in Program Mode. (FX button LED should be off.) In this mode, the MPX R1 sends MIDI Program Change and Bank Select messages to load MPX 1 programs.

Working in Program Mode

These four switches and continuous controller transmit specific MIDI System Exclusive or Control Change messages regardless of the mode of operation.

A/B Tap/Tempo, Bypass, Toe and Pedal

In this mode, the state of A/B and the Tempo LED rate will automatically update to the state of the currently loaded program. For example, if you load a program set to 100 beats per minute (BPM), the MPX R1 will flash at 100 BPM, just as the MPX 1 does. If you then load a program set to 120 BPM, the Tempo LED on the MPX R1 will increase from 100 to 120 BPM when the new program loads. Pressing and holding the **TAP** button on the MPX R1 will display the current tempo in BPM on the R1 display.

Loading Programs The first two digits on the display indicate the bank number. The third digit indicates the program number. The BANK buttons select banks, and switches 0-9 select programs within the displayed bank. Programs are loaded whenever one of the numbered switches is pressed.

To load a new program within the same bank, press any of the numbered switches (0-9).

To select a program in a different bank, press the BANK buttons to step to the bank you want, or hold down either button to scroll through the numbers. The rightmost digit, which is reserved for program numbers, will turn off during bank selection. Once you have selected the desired bank, press the numbered switch to load the program number within that bank.

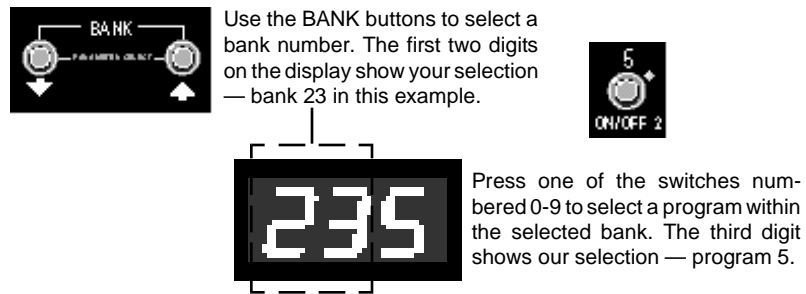

Direct Access Mode You can also enter program numbers directly in Direct Access Mode. Press and hold the **FX** button until its LED begins blinking. The display will flash **d-A** to indicate that Direct Access Mode is active. Now you can select programs by directly entering their program numbers. For example, to load MPX 1 Program 135, press **1**, then **3**, then **5** on the MPX R1.

In this mode, the BANK buttons increment and decrement the program numbers in consecutive steps.

Press the **FX** button once to exit to FX Mode, twice to exit to Program Mode.

FX Mode allows you to turn on and off any of the active effects in the current program. To access FX Mode, press the MPX R1 **FX** button. The LED next to the button will light to indicate you are in FX Mode.

FX Mode



The FX LED is lit when FX Mode is active.

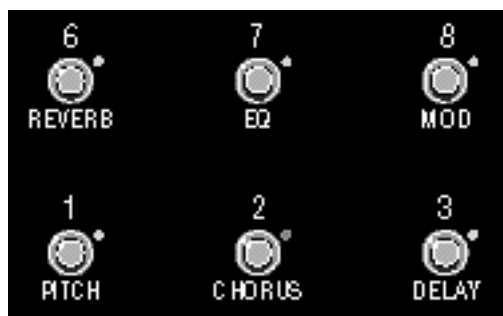

Buttons 1, 2, 3, 6, 7 and 8 bring MPX 1 effects (Pitch, Chorus, Delay, Reverb, EQ and Mod) in and out of bypass. The LED for each button indicates the current state of the MPX 1 Effect:

- Green = MPX 1 Effect on
- Red = MPX 1 Effect bypassed, but available
- Off = MPX 1 Effect unavailable

As in Program mode, the R1 will update to match the current MPX 1 A/B, Tempo and Bypass states of the currently loaded program. If you press any of these controls on the MPX 1, or if you load a new program from the MPX 1, the R1 will update accordingly.

You can also control the MPX R1 4-state relay in FX mode.

Relay State Programming

A relay is simply an electronic switch that can tell a circuit (typically an amp's channel-switching scheme, or reverb and tremolo status) what "state" to go to. Manufacturers use different schemes, or "logic states" to accomplish similar tasks, and the MPX R1 can be programmed to satisfy these requirements, allowing you, for example, to use your MPX R1 as a replacement for your amp's channel-switching footswitch.

Storing a Relay State

The relay state can be stored with each MIDI Program Change message. To do this, select the desired MIDI program on the MPX R1 and press the MPX R1 FX button to enter FX mode

The relay states are assigned to the following buttons as factory defaults.

- ON/OFF 1 = Relay state 1
- ON/OFF 2 = Relay state 2
- ON/OFF 3 = Relay state 3
- ON/OFF 4 = Relay state 4

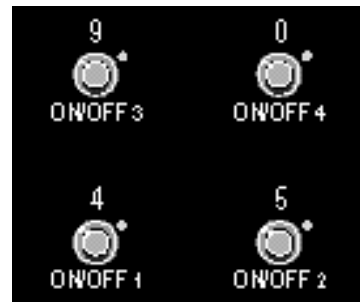

Press the button assigned to the desired relay state and hold the button down for two seconds. The relay state (for example, CH1) will flash three times on the MPX R1 display to indicate that it has been stored with the program.

Clearing a Relay State

To clear a relay state, press and hold any button *not* assigned to a relay channel. Hold this button down for two seconds until — — — flashes three times on the display to indicate the relay state for that program has been removed.

Removing Relay Settings for All Programs

To reset all of the relay settings to Not Assigned, go to Edit: Program Mode (Press and hold the rear panel EDIT/RUN switch until **Edt** appears on the display.) Use the BANK/Parameter Select buttons to select the Relay Initialize parameter (**rEi**). Press **Yes/+** to reset all of the relays. Note that the relays stay in their last state (based on the last physical button press) until a button is pressed to assign a different state. Briefly press and release the rear panel EDIT/RUN switch to exit Edit Mode.

Changing Programs vs. Bypassing Effects in a Guitar Rig

When you load a new program, it takes about 100 milliseconds for the MPX 1 to fade out the old program and then fade in the new program. (That's about a 16th note at 120 BPM.) For most musical situations that's plenty of time. For those situations where you really need to "nail" a sound change, you can be more precise by using the individual effect bypass buttons (in FX Mode) to instantly turn individual effects on or off.

For example, at the beginning of a tune, load a preset (using Program or Direct Access Mode) with the effects you want — say, Chorus, Delay and Reverb. Then, while you're playing, turn the desired effects on and off from FX Mode via the MPX R1 effect buttons.

Using the MPX 1 and the MPX R1 in a Guitar Amp Effects Loop

First, connect the Effects Loop Send(s) to the MPX 1 Input(s).

If the Effects Loop send has two outputs (L, R):

connect them to the left and right inputs of the MPX 1. On the MPX 1, press **System**, select **Input Mode** and set it to **Stereo**.

If the Effects Loop has only one output:

connect it to the left input of the MPX 1. On the MPX 1, press **System**, select **Audio: Input Mode** and set it to **Mono(L only)**.

Connect the MPX 1 Output(s) to the amp's Effects Loop Return(s)

If the Effects Loop has left and right return inputs:

connect them to the left and right outputs of the MPX 1.

If the Effects loop has only a single return input:

connect it to the left output of the MPX 1. (Effects will be richer if both outputs can be used, but MPX 1 V1.10 presets (100 through 159) have been optimized for use with only one output connected.)

If you are using the MPX 1 between a guitar preamp and power amp, refer to the following section on using a series effect loop.

If you are using the MPX 1 in a dry/wet (3-way) rig, refer to the following section on using a parallel effects loop.

Using the MPX 1 and the MPX R1 in a Preamp/Power Amp Rig or a Dry/Wet (3-Way) Rig

On the MPX 1:

Press **System** and make the following adjustments.

- Set **Pgm Bypass** to **Bypass**.
- Set **Audio Bypass Level** to **-3dB**.
(These settings will ensure that audio will be smooth and uninterrupted during program changes.)
- Set **Bypass Mode** to **Bypass**. (You will hear dry guitar when bypass is on.)
- Set **Mix Mode** to **Program** so that each program will load with its own independent master wet/dry mix value. (The master mix value for each preset is initially set to work with the MPX 1 in a series effect loop.)

Adjust Mix and Level Values as follows:

- To adjust the overall mix of dry guitar to all effects in any program: press **Mix**, select **Mstr Mix**, and change the value to suite your taste.
- To adjust the mix or level or any of the effects in the program: press **Mix**, select the **Mix** or **Level** parameter for the desired effect block and adjust. If you want to make the changes permanent, be sure to store your changes before loading a new program.

Set Input and Output Levels:

Before powering up the guitar amp, make your audio connections, turn the MPX 1 **Output Level** all the way down, and turn your guitar amp master volume all the way down.

This can be a little tricky, since you must set the MPX 1 output level to match the level of the preamp with nothing connected in the loop. If the levels are too low, the amp will not have its usual power and tone. If the levels are too high, you may overload the power amp – causing unwanted distortion. If your amp has a loop bypass (like a Mesa/Boogie Mk IV), it's pretty easy to match the levels. If not, it will take a little more work. The extra effort is worth it — when the levels are properly matched, your amp's tone will be unaffected and you will be able to use phase shifter, tremolo, wah and other "in-line" effects to their fullest potential.

- Power up the amp.
- Load MPX 1 Preset 100 **Guitar Solo**.
- Press **Bypass**.
- Set the preamp controls to the highest gain settings you'll be using.
- Turn up the MPX 1 Input Level control so that the 0 dB lights occasionally, then back it off a bit.

Using a Series Loop

What kind of effects loop do you have?

In a series effects loop, the entire preamp signal passes through the MPX 1. (If you turn down the MPX 1 Output Level control, no sound comes out of the amplifier.)

In a parallel loop, the preamp signal is routed directly to the power amp and the MPX 1 output is mixed with it. (If you turn down the MPX 1 Output Level control, you still hear the guitar at normal level.)

Some amps have a mix control for the loop. This is sometimes a switch labeled "50/50" or "mix," or a mix pot with a range of 0-100%. These controls allow you to use the loop as either series or parallel. With a switch, the 50/50, or mix, position corresponds to parallel, the other position corresponds to series. In the case of a mix pot, 100% corresponds to series and all other positions are parallel. (Halfway or 50% is a good starting place.)

- Bring up the amp master volume to a point corresponding to a reasonable listening level. (You won't hear anything yet.)
- Turn the MPX 1 Output Level control a little more than halfway up (at about 1:00 o'clock). You should now hear sound.
- Compare this level with the level when the MPX 1 is disconnected from the loop. (This is the tricky part — if your amp has a loop bypass, just bypass the loop. If it has a loop mix control, set the control to 0%. If not, you may have to physically disconnect the MPX 1 from the loop.)
- Adjust the MPX 1 Output level control so that the amp's loudness is the same as when the MPX 1 is not in the loop.

Using a Parallel Loop

On the MPX 1:

Press **System** and make the following adjustments.

- Set **Pgm Bypass** to **Mute**.
- Set **System Bypass Mode** to **Input Mute** (delay and reverbs will “ring out” when Bypass is on) or **All Mute** (effects are muted when Bypass is on).
- Set **Mix Mode** to **Global**, press **Mix** and set **Mstr Mix** to **100%**.

Adjust Mix and Level Values as follows:

- To adjust the overall mix of dry guitar to all effects in any program, press **Mix**, select **Mstr Level**, and change the value to suite your taste.
- To adjust the mix or level of any of the effects in the program: press **Mix**, select the **Mix** or **Level** parameter for the desired effect block and adjust. (If you want to make the changes permanent, be sure to store your changes before loading a new program.)

Set Input and Output Levels:

Before powering up the guitar amp, make your audio connections, turn the MPX 1 **Output Level** all the way down, and turn your guitar amp master volume all the way down.

[This is pretty simple, as you're just adding the MPX 1 output to your normal guitar sound.]

- Power up the amp.
- Load MPX Preset 100, **Guitar Solo**.
- Set the preamp controls to the highest gain settings you'll be using.
- Turn up the Input Level control so that the 0 dB lights occasionally when you're playing your loudest, then back it off a bit.
- Bring up the amp master volume to the desired listening level.
- Turn up the MPX 1 **Output Level** to the desired effects level.

The MPX R1 can be used as a stand-alone controller for any standard MIDI device. When used this way, the MPX R1 transmits MIDI Program Change and Control Change messages, and controls the built-in 4-state relay.

Using the MPX R1 with Other MIDI Devices

Connect a 5-pin DIN MIDI cable between the MPX R1 rear panel OUT/REMOTE jack and MIDI IN jack of the device you wish to control. Connect the Lexicon MSA Adapter between the POWER jack on the MPX R1 and a wall outlet.

Connections

To control multiple devices, connect MIDI cables between the MIDI IN ports of each new device and the THRU ports of each preceding device.

When the MPX 1 powers up, it will default to Program Mode. The MPX R1 should also power up in Program Mode. (FX button LED should be off.) In this mode, the MPX R1 sends MIDI Program Change and Bank Select messages to load MPX 1 programs.

Working in Program Mode

These four switches transmit information regardless of the mode of operation. They can be programmed to output an of the sources listed in Edit: FX Mode.

A/B, Tap/Tempo, Bypass and Toe Switch

The first two digits on the display indicate the bank number. The third digit indicates the program number. The BANK buttons select banks, and switches 0-9 select programs within the displayed bank. Programs are loaded whenever one of the numbered switches is pressed.

Loading Programs

To load a new program within the same bank, press any of the numbered switches (0-9).

To select a program in a different bank, press the BANK buttons to step to the bank you want, or hold down either button to scroll through the numbers. The rightmost digit, which is reserved for program numbers, will turn off during bank selection. Once you have selected the bank you want, press the numbered switch to load the desired program within that bank.



Use the BANK buttons to select a bank number. The first two digits on the display show your selection — bank 23 in this example.



Press one of the buttons numbered 0-9 to select a program within the selected bank. The third digit shows our selection — program 5.

Direct Access Mode You can also enter program numbers directly in Direct Access Mode. Press and hold the **FX** button until its LED begins blinking. The display will flash **d-A** to indicate that Direct Access Mode is active. Now you can select programs by directly entering their program numbers. For example, to load MPX 1 Program 135, press **1**, then **3**, then **5** on the R1.

In this mode, the **BANK** buttons increment and decrement the program numbers in consecutive steps.

Press the **FX** button once to exit to FX Mode, twice to exit to Program Mode.

FX Mode FX Mode allows you to use the MPX R1 buttons numbered 0-9 as MIDI Controllers. To access FX Mode, press the MPX R1 **FX** button. The LED next to the button will light to indicate you are in FX Mode.



The FX LED is lit when FX mode is active.

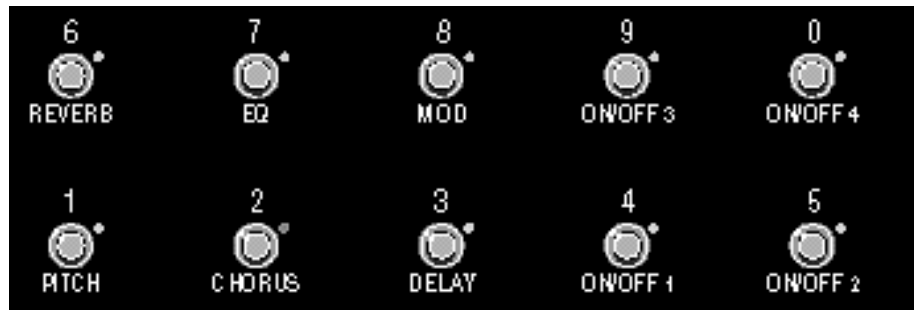

Buttons 0-9 can be assigned to any of the following MIDI controllers:

- | | |
|-------------------------------|------------|
| Continuous Controllers 1-31 | Start/Stop |
| Continuous Controllers 33-119 | Start |
| A-B | Stop |
| Tip | Continue |
| Ring | Reset |
| CH1-4 | Bypass |

For additional information on all of these sources, refer to Chapter 4 Editing: FX Parameters.

In FX Mode, transmitted values correspond to the state of the switch and are indicated by the switch LEDs as follows:

- Green = 127 transmitted
- Off = 0 transmitted

Note that when used as a stand-alone controller, on and off are the only LED indicators available. Note also that the LEDs for all of the buttons will remain in their last toggled states.

You can also control the MPX R1 4-state relay in FX Mode.

Relay State Programming

Storing a Relay State

The relay state can be stored with each MIDI Program Change message. To do this, select the desired MIDI program on the MPX R1 and press the MPX R1 FX button to enter FX mode.

The relay states are assigned to the following buttons as factory defaults.

ON/OFF 1 = Relay state 1
 ON/OFF 2 = Relay state 2
 ON/OFF 3 = Relay state 3
 ON/OFF 4 = Relay state 4

Press the button assigned to the desired relay state and hold it down for two seconds. The relay state (for example, CH1) will flash three times on the MPX R1 display to indicate that it has been stored with the program.

Clearing a Relay State

To clear a relay state, press and hold any button *not* assigned to a relay channel. Hold this button down for two seconds until --- is flashed three times on the display to indicate the relay state for that program has been removed.

Removing Relay Settings for All Programs

To reset all of the relay settings to Not Assigned, go to Edit: Program Mode and select the Relay Initialize parameter (**rEi**). Press **Yes/+** to reset all of the relays. Note that the relays will stay in their last state (based on the last physical button press) until a button is pressed to assign a different state.

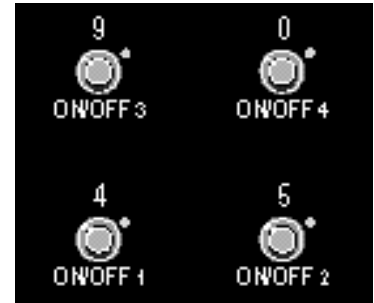

MPX R1 edit functions, like basic operations, are divided into two modes by the front panel Program/FX switch. EDIT: Programs allows you to access system parameters such as MIDI Channel, Relay state, MIDI Clock, etc. EDIT: FX allows you to re-assign the MIDI controllers transmitted by the MPX R1 front panel buttons.

To access EDIT mode, press and hold the MPX R1 rear panel EDIT/RUN switch. (This recessed switch has been designed for easy access with a guitar pick, pen point or fingernail.) After three seconds, the MPX R1 display will flash **Edt** twice, and the first Program mode parameter will appear as a default. The front panel **A**, **B** and **Tempo** LEDs will all light to indicate that the unit is in EDIT Mode. (To exit, press and release the EDIT/RUN switch.)

Editing

Press and hold the rear panel EDIT/RUN switch to access the MPX R1 Editing functions.



The A, B and Tempo LEDs will all light to indicate you are in Edit mode.

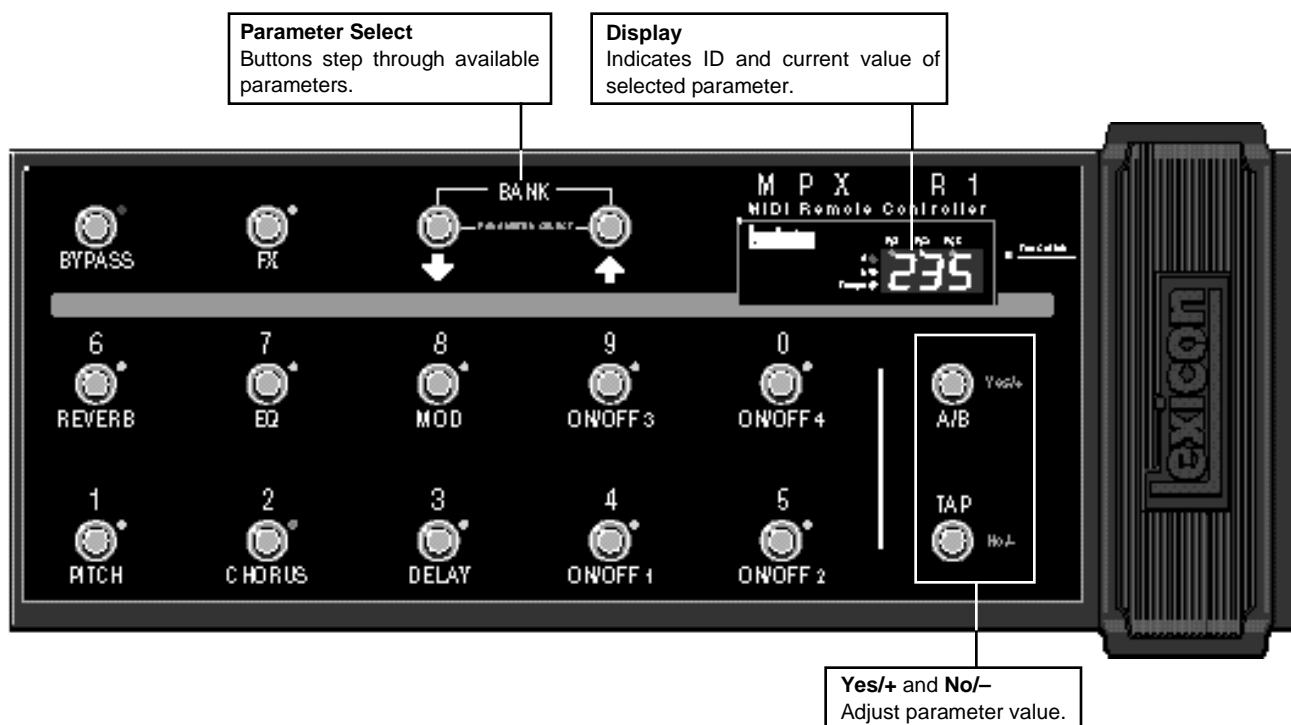













In either mode, the front panel BANK/Parameter Select buttons will step through the list of available parameters. The abbreviated name of each parameter will flash alternately on the display with the current parameter setting.





Parameter values are adjusted with the front panel **YES/+** and **NO/-** buttons. Changes made to parameter values are immediate.

The following pages list all of the editable parameters in the MPX R1. An Edit Summary showing this information in abbreviated form, is provided on an adhesive chart, to stick onto the bottom of the MPX R1 for easy reference.

Edit Mode Program Parameters

- | | | | |
|-------------------------------------------------------------------------------------------------------------------------------------------------|-------------------------------------------------------------------------------------|-----------------------------------------------------------------------------------------------------------------------------------------------------------------------------------------------------------------------------------------------------------------------------------------------------------------------------------------------------------------------------------------------|---------------------|
| 1 |  | MIDI System Channel Assign
Assigns the MIDI transmit channel (1-16) for all buttons (except TOE). | Default: 1 |
| 2 |  | MIDI Internal Pedal Channel Assign
Assigns the MIDI transmit channel (1-16) for the onboard foot pedal. | Default: 1 |
| 3 |  | MIDI External Pedal Channel Assign
Assigns the MIDI transmit channel (1-16) for the external foot pedal/Analog controller. | Default: 1 |
| 4 |  | MIDI Toe Channel Assign
Assigns the MIDI transmit channel (1-16) for the Toe switch. | Default: 1 |
| 5 |  | External Foot Switch #1 State Select
Selects the foot switch state (Latching=1 or Momentary=2) for external foot switch #1. This allows a momentary foot switch to act like a latching foot switch. For momentary foot switches, leave this at the default setting (2). | Default: 2 |
| 6 |  | External Foot Switch #2 State Select
Selects the foot switch state (Latching=1 or Momentary=2) for external foot switch #2. This allows amomentary foot switch to act like a latching foot switch. For momentary foot switches, leave this at the default setting (2). | Default: 2 |
| 7 |  | External Foot Switch #3 State Select
Selects the foot switch state (Latching=1 or Momentary=2) for external foot switch #3. This allows a momentary foot switch to act like a latching foot switch. For momentary foot switches, leave this at the default setting (2). | Default: 2 |
| 8 |  | MIDI Clock Output On/Off
Specifies the source of MIDI clock output. Settings include: Off, On (generate internally), re (merge from remote in), in (merge from MIDI in). | Default: Off |
| 9 |  | Program Load mode
Determines how program numbers are entered. Two states (indicated below by a /, indicates a second mode is available by pressing and holding down the FX button.(In the second mode, the FX light blinks.) | Default: 3 |
| 1 = Banks
2 = Direct Access Mode
3 = Banks/Direct Access
4 = Banks/Direct Device
5 = Setup/Direct Access
6 = Setup/Direct Device | | | |
| 10 |  | Redundant Program Change On/Off
When set to On (the default), the remote will send a redundant program change message. (If you select the same program number (0-9) as the program that is loaded, the remote will send that program change.) When set to Off, the remote will not send a new program change if the program corresponding to the number selected is already loaded. | Default: On |

- 11 **PnF** **Program Number Format Select** **Default: 1**
 Allows selection of one of two numbering systems: 0-127 (0) or 1-128 (1) for program numbering. This is a display change only — In MIDI terms, the remote will always send 0-127 values.
- 12 **bLS** **Bank Limit Select** **Default: 25**
 When the MPX R1 is not connected to an MPX 1 (which forces 25 banks), a maximum bank number can be selected here to limit the total number of accessible banks. The available range is 0-99.
- 13 **PPb** **Programs Per Bank** **Default: 100**
 Specifies the number of programs in each bank (and thereby tells the MPX R1 when to send a bank change message). The available range is 1-128.
- 14 **bC** **Bank Change** **Default: 32**
 Allows selection of the MIDI Controller number to be used as the transmitted Bank Select message, 0, 32 or 032.
- 15 **PCS** **Pedal Curve Select** **Default: 1**
 Allows selection of a pedal curve. The available settings are 1-3.
- 1  2  3 
- 16 **P-rL** **Pedal Range Limit Low** **Default: 0**
 Sets the controller value (0-127) transmitted when the pedal is in its lowest position.
- 17 **P-rh** **Pedal Range Limit High** **Default: 127**
 Sets the controller value (0-127) transmitted when the pedal is in its highest position.
- 18 **ECS** **External Pedal Curve Select** **Default: 1**
 Selects a pedal curve (1-3).
- 19 **E-rL** **External Pedal Range Limit Low** **Default: 0**
 Sets the controller value (0-127) transmitted when the pedal is in its lowest position.
- 20 **E-rh** **External Pedal Range Limit High** **Default: 127**
 Sets the controller value (0-127) transmitted when the pedal is in its highest position. The default setting is 127.
- 21 **UPd** **Pedal Update Mode** **Default: On**
 When set to On, the pedal will update the current pedal controller value immediately. When pedal update is set to Off, the pedal controller value will only be updated when the pedal is moved.
- 22 **PC** **Internal Pedal Calibration** **Default: Off**
 Calibrates the pedal when **Yes/+** is selected. Moving the pedal through its entire range of travel will re-calibrate the range of the pedal (i.e. 0 for minimum value, 127 for maximum value).



















- | | | | |
|----|-------------------------------------------------------------------------------------|------------------------------------------------------------------------------------------------------------------------------------------------------------------------------------------------------------------------------------------|----------------------------|
| 23 |  | External Pedal Calibration
Calibrates the pedal when Yes/+ is selected. Moving the pedal through its entire range of travel will re-calibrate the range of the pedal (i.e. 0 for minimum value, 127 for maximum value). | Default: Off |
| 24 |  | MIDI IN Merge On/Off
When set to On, MIDI data received at the MIDI IN jack will be merged to the MIDI OUT jack. | Default: Off |
| 25 |  | MIDI THRU Routing Select
Allows data from MIDI IN (in) or MIDI remote (rE) to be passed to the THRU port. | Default: rE |
| 26 |  | Relay Mode Select
Allows you to choose how the relay operates. The choices are: 1=latching, 2=momentary normally open, 3=normally closed. | Default: 1 |
| 27 |  | Relay Initialize
Initializes all of the stored relay states. Choices are Yes or No. | Default: – |
| 28 |  | Tempo LED On/Off
Allows you to turn the Tempo LED On or Off. The LED is normally On. | Default: On |
| 29 |  | Device ID Assign Mode
Sets a Device ID number (0-126) for the remote. | Default: 0 |
| 30 |  | Target ID Assign Mode
Set a Target ID number (0-126) for the remote. | Default: 0 |
| 31 |  | MIDI Dump All
When Yes/+ is pressed, all global settings, system parameters, controller assignments, relay states and setup information will be dumped via SysEx to the MIDI OUT port. | Default: – |
| 32 |  | MIDI System Dump
When Yes/+ is pressed, all system parameters will be dumped via SysEx to the MIDI OUT port. | Default: – |
| 33 |  | MIDI Controllers Dump
When Yes/+ is pressed, all Controller Assignments will be dumped via SysEx to the MIDI OUT port. | Default: – |

Note: When the relay state is assigned to a selected button the relay will automatically change to reflect the current state of the button. Relays with dual states will default to the first state.

Edit Mode FX Parameters

Note: In this mode, pressing any button will transmit the currently assigned controller. On exiting this mode, all switches will revert to the state they were in before Edit Mode was entered.

Each of the following buttons can be assigned to the following MIDI controllers: 1-31, 33-119, Start/Stop, Start, Stop, Continue, Reset, tip, ring, CH1, CH2, CH3, CH4, Off, Bypass, MPX 1 SysEx message for A/B.

1		Bypass	Default: CC84
2		1/Pitch	Default: CC77
3		2/Chorus	Default: CC78
4		3/Delay	Default: CC76
5		4/On/Off 1	Default: CH1
6		5/On/Off 2	Default: CH2
7		6/Reverb	Default: CC75
8		7/EQ	Default: CC73
9		8/Mod	Default: CC70
10		9/On/Off 3	Default: CH3
11		0/On/Off 4	Default: CH4
12		A/B 1	A/B SysEx
13		A/B 2	Off
14		Toe	Default: CC83
15		Internal Pedal	Default: CC4
16		External Pedal	Default: CC11
17		External Footswitch 1	Default: CC80
18		External Footswitch 2	Default: CC81
19		External Footswitch 3	Default: CC82

Pressing any switch assigned to Bypass will disable all buttons, LEDs and controllers. While this switch is engaged, the LED for the button will light, and the display will flash **SuS** (suspended).

Note that the **A/B** button can be assigned to simultaneously output two separate controllers. (It is designed to simultaneously toggle the A/B state of the MPX 1 and the relay for amplifier switching.)

The Relays

Two MPX R1 relays can operate in one of three modes: latching, momentary normally open, and momentary normally closed. The Edit: Program parameter **rel** allows you to select one of these options.

Relay Tip

To find out what relay state scheme your amp uses, connect a 1/4" TRS cable between the MPX R1 and the amp's rear panel jack for amp switching. Experiment by pressing the four MPX R1 relay state switches to determine how the default settings of the MPX R1 affect your amp's channel-switching scheme. Write down the results before editing custom states and setups.

The relays are activated by pressing a button assigned to the tip relay, the ring relay, or to one of four channels. Any button can be assigned to turn the tip or the ring relay on and off. You can also assign any one of the four channels to any button. The relay jack accepts a 1/4" TRS connector.

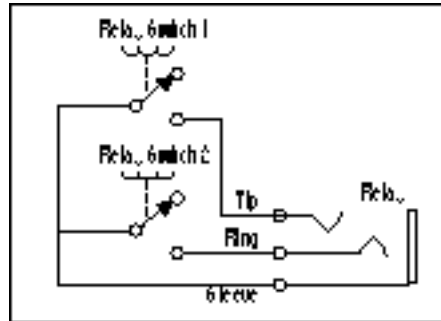

Latching Tip/Ring

Pressing the button assigned to Tip causes the tip relay to change state. Pressing the button assigned to Ring causes the ring relay to change state.

Channels

Pressing a button assigned to a channel causes the channel to change. The four channels are defined as shown below:

Channel	Tip Relay	Ring Relay
1	open	open
2	closed	open
3	open	closed
4	closed	closed

Momentary, normally open Tip/Ring

The tip and ring relays are defined as being normally open. Pressing the button assigned to the tip or the ring relay closes the relay for 100ms and then opens it again.

Channels

The "momentary, normally open" state of a channel is Channel 1. Pressing a channel button causes the relay to momentarily change to that channel's state and then change back to Channel 1. (Pressing a button assigned to Channel 1 does nothing.)

Momentary, normally closed Tip/Ring

The tip and ring relays are defined as being normally closed. Pressing the button assigned to the tip or the ring relay opens the relay for 100ms and then closes it again.

Channels

The “momentary, normally closed” state of a channel is Channel 4. Pressing a channel button causes the relay to momentarily change to that channel’s state and then change back to Channel 4. (Pressing a button assigned to Channel 4 does nothing.)

Storing a Relay State

The relay state can be stored with each MIDI Program Change message. To do this, select the desired MIDI program on the MPX R1.

Press the MPX R1 FX button to enter FX mode.

In the MPX R1 the relay states are assigned to the following buttons as factory defaults.

ON/OFF 1 = Relay state 1
 ON/OFF 2 = Relay state 2
 ON/OFF 3 = Relay state 3
 ON/OFF 4 = Relay state 4

Press the button assigned to the desired relay state and hold the button down for two seconds. The relay state (for example, CH1) will flash on the MPX R1 display to indicate that it has been stored with the program.

Clearing a Relay State

To clear a relay state, press and hold any button *not* assigned to a relay channel. Hold this button down for two seconds until --- is flashed on the display to indicate the relay state for that program has been removed.

Latching

To assign the relay using tip or ring when the relays are set to latching mode:

Assign the relay state to the desired button. This button will now have two relay states: State 1 (Green) and State 2 (Off).

Follow the same method for assigning the relay as above. To save the CH1 relay state, the button must first be put in CH2 relay. Then, when you press and hold this button it will toggle the to the CH1 relay state.

Momentary

If the relays are set to momentary, normally closed, or to momentary, normally open, you can store a momentary change on either the tip or the ring relay.

To reset all of the relay settings to Not Assigned, go to Edit: Program mode and select the Relay Initialize parameter (**rEi**). Press Yes to reset all of the relays. Note that the relays will stay in their last state (based on the last physical button press) until a button is pressed to assign a different state.

Relay State Programming

Assigning the Relay with tip and ring

Removing Relay Settings for all programs

Advanced Applications

The MPX R1 is capable of simultaneously outputting multiple MIDI Program Change messages (called Setups) on as many as eight different MIDI channels. It can access any MIDI channel and transmit Program Change messages in real time. Each of these applications is described in this section.

Transmitting Multiple Program Changes on Separate MIDI Channels

A Setup consists of as many as eight MIDI Program Change messages and one relay state. The MPX R1 can be programmed with as many as 100 Setups.

Setups

To activate Setups or Direct Device Control from Program mode you must select 4, 5 or 6 as a setting for the **PL** (Program Load) parameter in Edit mode. This parameter allows you to select one of the following six options as a master mode for program load behavior:

Activating Setups and Direct Device Control

- | | |
|---|----------------------|
| 1 | Banks |
| 2 | Direct Access |
| 3 | Banks/Direct Access |
| 4 | Banks/Direct Device |
| 5 | Setups/Direct Access |
| 6 | Setups/Direct Device |

4 Banks/Direct Device uses the standard bank loading scheme on a single MIDI channel selected in Edit Program Mode. Pressing and holding the **FX** button (from either Program or FX Mode) until the LED blinks and **d-d** flashes on the MPX R1 display activates Direct Device Control. Pressing **FX** again reverts to the standard bank loading scheme.

5 Setups/Direct Access activates Setup Mode. In this mode, all MIDI Program Changes are transmitted within Setups. Pressing and holding the **FX** button takes you into a version of Direct Access Mode which gives you direct access only to Setup load. Pressing **FX** again reverts to Setup Mode.

6 Setups/Direct Device activates Setup Mode. In this mode, all MIDI Program Changes are transmitted within Setups. Pressing and holding the **FX** button (from either Program or FX Mode) until the LED blinks and **d-d** flashes on the R1 display activates Direct Device Mode. Pressing **FX** again reverts to Setup Mode.

To build a Setup, first set the rear panel EDIT/RUN switch to Edit Mode, then press and hold the **FX** button for approximately 2 seconds, until the **FX** LED blinks.

Creating a Setup

The **1/PITCH** LED should light up in red and the display should show **SEt** to indicate you are in Setup programming mode.

The front panel **Yes/+** and **No/-** buttons allow you to select a Setup number (1-100) for programming. This number is assigned to the **1/PITCH** button.

Each of the MPX R1 front panel buttons numbered 2-9 is now available to memorize Program Change messages. (Button **0/ON/OFF 4** is available for storing a relay state.)

Select the button you want (2-9) to designate a particular MIDI device.

MPX R1 Button

2/CHORUS	Device 1
3/DELAY	Device 2
4/ON/OFF 1	Device 3
5/ON/OFF 2	Device 4
6/REVERB	Device 5
7/EQ	Device 6
8/MOD	Device 7
9/ON/OFF 3	Device 8

Setup Parameters The BANK buttons will now select one of four parameters available to define the Program Change messages you want to send. The **Yes/+** and **No/-** buttons set the value for each parameter you select.

PC (Program Change) lets you select a MIDI Program Change message (0-999) for the selected device. This parameter is specific to each Setup.

Ch (MIDI Channel) lets you select a MIDI Channel (1-16) for communication with the selected device. This channel will be used for any devices assigned to this button. This parameter is global for each device.

PPb (Programs Per Bank) lets you specify the number of programs in each bank (0-999), and therefore, when a bank change message will be transmitted. This parameter is global for each device.

bC (Bank Change Message) lets you define the Bank Select message (0, 32 or 032) to be transmitted to the selected device. This parameter is global for each device.

Once these parameters have been set, you can test the device by pressing **2/CHORUS**. This will output all of the MIDI information you have programmed for the selected device.

To select a relay state to store with the Setup, press **0/ON/OFF 4**. This button is reserved for Setup relay state assignments. When you press the button, the display should show **rEL.** on the display)

The **Yes/+** and **No/-** buttons allow you to select the relay state you want stored with the Setup.

Clearing a Setup To clear a Setup, go to Setup Edit mode, and select the number of the Setup you want to clear, and hold down the **BYPASS** button. All of the front panel LEDs except **1/PITCH** will turn off, indicating that the Setup has been cleared.

Example

1. Press the button for the desired device. The LED will blink green. The first parameter (Program Change) will be indicated by **PC** on the display.
2. Use the **Yes/+** and **No/-** buttons to select a Program Change number.
3. Use the BANK buttons to select the next parameter, MIDI Channel.
4. Use the **Yes/+** and **No/-** buttons to select a MIDI Channel.
5. Use the BANK buttons to select the next parameter, Programs Per Bank.
6. Use the **Yes/+** and **No/-** buttons to select the appropriate number for the connected device.
7. Use the BANK buttons to select the next parameter, Bank Change.
8. Use the **Yes/+** and **No/-** buttons to select the appropriate setting for the connected device.

Once all of the parameters have been set and you want to test this specific device Program Change message, press the button you have selected to designate the device.

Once you press any other device button, this LED will light steady green to indicate that information is stored at this location.

Direct Device Control Mode is similar to Direct Access, except that the Bank buttons change the MIDI Channel for Program Changes in real time.

Direct Device Control

In either Program or FX Mode, press and hold the **FX** button until the **FX** LED blinks and **d-d** is flashed on the display. The display will then alternate the display of the current MIDI Channel and the last Program Change number transmitted on that channel.

In this mode you can select programs directly by entering their numbers as button pushes (as in Direct Access). In addition, the Bank buttons let you access MIDI Channels 1-16 so that you can transmit a Program Change on any MIDI Channel in real time.

When you press the **FX** button again you will revert to the Program Load mode specified by the **PL** parameter in Edit Mode with the MIDI Channel reset to the channel specified by the **Ch** parameter, or to that specified for the Setup.

Alternative Connections The following methods allow you to establish two-way MIDI communication between an MPX R1 and an MPX 1 without using a 7-pin MIDI cable.

2 MIDI cables and an MSA Adapter Connect a 5-pin MIDI cable between the MPX R1 rear panel OUT/REMOTE jack and the MPX 1 rear panel MIDI IN/REMOTE jack.

Connect a second 5-pin MIDI cable between the MPX 1 rear panel MIDI OUT jack and the MPX R1 rear panel MIDI IN jack.

Connect the MSA Adapter to the MPX 1 rear panel POWER jack and plug into a wall outlet.

5-pin connection (1 cable for two-way MIDI with power from an adapter) If you have a 5-pin MIDI cable which has all five pins wired, connect it between the MPX R1 rear panel OUT/REMOTE jack and the MPX 1 rear panel MIDI IN/REMOTE jack.

Connect the MSA Adapter to the MPX 1 rear panel POWER jack and plug into a wall outlet.

Troubleshooting

This chapter is intended primarily to help you recognize some common error states which can be corrected from the MPX R1 front panel, or by simple means such as cable replacement. Any error states that are not covered here should be referred to your local dealer or Lexicon Customer Service.

In “low-voltage”, or “brown-out” conditions (less than 40VAC), the MPX R1 will freeze in its current state. None of the controls will have any effect. When power returns to a normal level, the unit will reset itself as though it had just been powered on. If the unit does not reset itself, turn the power OFF, then ON to resume normal operation.

Low Voltage

Temperature extremes may cause the MPX R1 to exhibit unpredictable behavior. If the unit has been subjected to temperatures below 32°F (0°C) or above 95°F (35°C), it should be turned off and allowed to return to normal temperature before use. The unit may be damaged by exposure to temperatures below -22°F (-30°C) or above 167°F (75°C), or by exposure to humidity in excess of 95%. If a unit exposed to such conditions fails to operate after it returns to a normal operating temperature, contact your local service representative.

Overheating

The MPX R1 doesn't respond to MIDI Program Changes.

The MPX R1 and connected devices must be set to matching MIDI Channels. Check the connected device (if an MPX 1, check in the **System** mode **MIDI** menu) as well as in the MPX R1 Edit mode to verify MIDI channel selections.

Common MIDI Problems

If connected to an MPX 1:

Make sure that **Pgm Change** in the MPX 1 System mode **MIDI** menu is set to **On**. See MPX 1 User Guide Chapter 6: *MIDI Operation* for Program Change messages which may be ignored by the MPX 1.

Check MIDI connections between the units.

Adjusting Pedal Tension

The tension of the foot pedal can be adjusted tighter or looser according to your preference. Use a #2 Phillips-head screwdriver to adjust the screw located on the right side of the pedal (as viewed from the top).

Reinitialization

Reinitialization of the MPX R1

On the MPX R1, press the **0 (ON/OFF 4)** button while powering up. When all of the LEDs begin blinking, release the **0** button and press **FX** to initialize the foot controller. (Press any other button to cancel the initialization procedure.) This will reset all of the MPX R1 parameters to the default states listed in Chapter 4.

Reinitialization of the MPX 1 and the MPX R1

On the MPX 1, press **System** and turn the knob to select **Initialize**. Press the **>** button repeatedly to step to the last selection in the Initialize menu: **MPX 1/MPX R1**. The **Store** button will flash, indicating that the MPX 1 is armed to perform the initialization procedure.

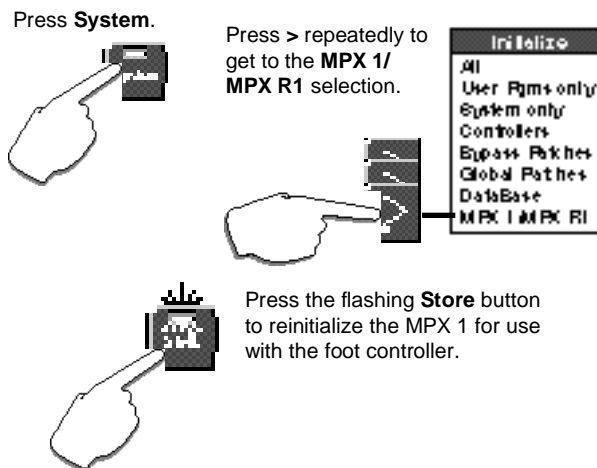

Press **Yes** to initialize. Press any other button to disarm the initialize function.

Specifications

Dimensions:	23 in x 8 in x 3 in (WHD) (58.42 cm x 20.32 cm x 7.62 cm)
Weight:	9.5 lbs (4.3 kg)
Construction:	All metal chassis, switches and expression pedal
External control inputs:	1 1/4" TRS jack supports up to 3 on/off switches 1 1/4" TRS jack for external expression pedal
Internal relays:	1 1/4" TRS jack connected to two internal programmable relays
MIDI:	MIDI OUT/REMOTE: 7-pin DIN connector (compatible with standard 5-pin MIDI) provides phantom power and two-way MIDI communication with the MPX 1 MIDI IN: standard MIDI IN can also be used to merge a second MIDI input stream when MIDI OUT/REMOTE is connected MIDI THRU: can be set to pass MIDI from either MIDI IN or REMOTE ports
Power:	9VAC, 1A wall transformer provided 25-foot 7-pin DIN cable for phantom power via MPX 1
Expression pedal:	vintage mechanical design, all steel construction, programmable toe switch
Display:	3-digit LED indicates program number and tempo rate
MIDI functions:	MIDI bank and program select for up to 300 programs Switches and pedal(s) can be individually set to transmit any controller. The status of each MIDI switch is indicated with a green LED. Tap tempo can be transmitted as MIDI Clock
Relay mapping:	Different relay states can be memorized for each of 990 MIDI program numbers Relays can operate as on/off 1–4 or as two independent on/off switches
MPX 1 functions*:	When connected to an MPX 1 via 7-pin cable, R1 LEDs automatically display the following each time a new program is loaded: Program number Master Bypass state A/B state Tempo rate State of each effect block (Pitch, Chorus, EQ, Mod, Delay, Reverb); effect on=green, effect bypassed=red, effect not active=off The state of any active effect can be instantly changed by pressing its associated switch Dedicated switches for control of A/B and Tap.

* MPX 1 requires V1.1 ROM upgrade

MIDI Implementation Chart

Lexicon MPX R1
MIDI Remote Controller

Function		Transmitted	Recognized	Remarks
Basic Channel	Default	1	X	
	Changed	1-16	X	
Mode	Default	X	X	
	Messages	X	X	
	Altered		X	
Note		X	X	
Velocity	Note ON	X	X	
	Note OFF	X	X	
After Touch	Keys	X	X	
	Channel	X	X	
Pitch Bend		X	X	
Control Change	1-119 BYPASS, PITCH, CHORUS, DELAY, ON/OFF1-4, REVERB, EQ, MOD, FS 1-3, TOE SWITCH, INTERNAL PEDAL 1-2	OX	X	OFF, 1-119, Start/Stop Start, Stop, Continue, Rest, Tip, Ring, CH1-4, Off, BYP (0, 32, 032 select Banks). All transmit ON= 127; OFF=0 INTERNAL PEDAL 1 and 2 are continuous controllers
Program Change	True # Bank Select	0-127	X	Bank change allows access to programs 0-300
		1-128 O	O	
System Exclusive	Lexicon	OX	OX	Limited set of SysEx messages
System Common	:Song Pos	X	X	
	:Song Sel	X	X	
	:Tune	X	X	
System Real Time	:Clock	OX	X	Default set to OFF but can be turned on. Default tempo=120bpm
	:Commands	OX	X	
Aux Messages	:Local ON/OFF	X	X	
	:All Notes OFF	X	X	
	:Active Sense	X	X	
	:Reset All Controllers	OX	X	
Notes				

Mode 1: OMNI ON, POLY
Mode 3: OMNI OFF, POLY

Mode 2: OMNI ON, MONO
Mode 4: OMNI OFF, MONO

O : Yes **OX: Selectable**
X : No

Lexicon Inc.
3 Oak Park
Bedford MA 01730-1441 USA
Telephone 781-280-0300
Fax 781-280-0490
www.lexicon.com

Lexicon Part # 070-12712